



**KEYLIGHT**  
**SPAIN**  
LIGHTING PRODUCTS



LED STRIPS & ALUMINUM PROFILING





# ABOUT US

**Keylight Spain** is a leading specialist in lighting products from Valencia, Spain.

We use the latest **LED technology** to create a unique range of lighting solutions.

Known by the high quality of our materials and innovative approaches when it comes to lighting, we offer a comprehensive selection of products, including LED lights, luminaires, drivers, control systems, accessories and more.

Our creative scope allows us to tackle even the most complex lighting projects, while our extensive experience and customer service ensure your lighting needs are met with the utmost satisfaction.

Therefore, our mission is to meet and satisfy the needs of our clients, with tailored products and services including collaborative marketing campaigns and market-specific product design to support our partners worldwide.

# **LED STRIPS**

ALUMINUM  
PROFILING

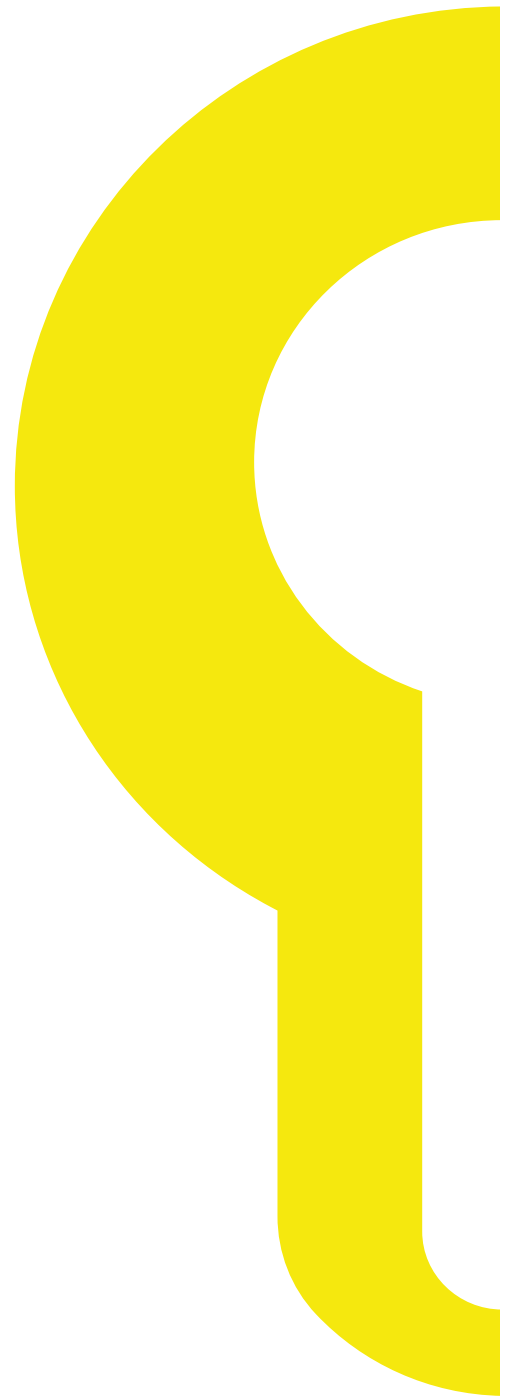

**PRODUCT SIZE**

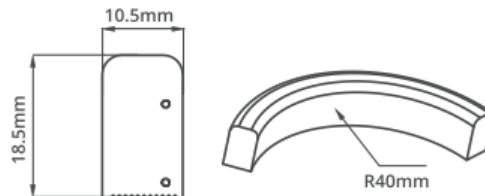

**AZ-2408- U500**

<b>Model</b>		AZ-2408 U500
<b>Physical Specification</b>	IP grade	IP65 (Male and Female Connector)
	driver	Rectifier
	Manufacture process	SMT
	Connection	Male and Female Connector/Simple Connector
	Minimum cutting length	10CM ( 4'' )
	Max. running length	20M/Roll(66FT)
	storage temperature	-30~50 °C
	operating temperature	-20~40 °C
	suitable environment humidity	0-90%
Lifespan(h)	20000	
<b>Electronic Specification</b>	output voltage	DC24V
	Power(W)	8W±10%
	Pressure testing rate	CLASS III
	insulation grade	CLASS III
	Control System	N/A
<b>Mechanical &amp; Physical Specification</b>	LED Source	SMD2835
	LED power	0.1W
	LED quantity	108led/Meters
	CCT	2700K±300K 4000±300K 6000±500K R/B
	luminous flux	200LM±10%
	CRI ( Ra )	>70
	beam angle	120°
<b>Others</b>	Dimension	10.5mm*18.5mm
	installation	With Aluminum Profile
	material	Copper wire and PVC lamp body
	G.W.	5.3KG /CTN
	N.W.	5.8KG/CTN
	Unit product packing	Natural Carton
	carton size (mm)	285*285*140MM
	max.package amount	25PCS
<p>Note: 1.All parameters NOT specially mention are measured at 240VAC input and 25 °C of ambient temperature.</p>		

# INSTALLATION

## 1 Molded connector

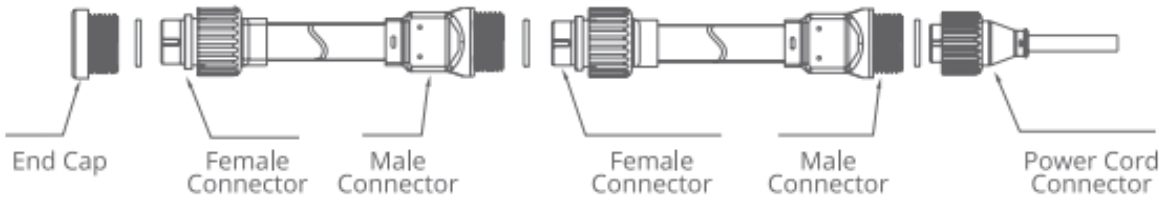

Length: 1.2m, 2x1.0mm<sup>2</sup> Rubber Wire in the Front with Male Connector



Male and Female Connector



5cm Aluminum profile with screw

## 2 Simple Assembled Connector



Length: 1.2m, 2x1.0mm<sup>2</sup> Rubber Wire in the Front with glue connector + End cap + Pin



Middle Connector + Pin



5cm Aluminum Profile with 2 screws



<b>Product</b>	AZ-5191A
<b>IP Rating</b>	IP20
<b>ROHS Instruction</b>	Environmental protection
<b>Connection Type</b>	Simple type wire connection
<b>Color Temperature</b>	3000/4000/6000K
<b>Lifetime(h)</b>	30000H
<b>Input Power(W)</b>	15±10%W/ M
<b>Input voltage</b>	12VD C
<b>Power Factor</b>	>0.9
<b>Storage Temperature</b>	-30°C~+50°C
<b>Working Temperature</b>	-20°C~+40°C
<b>Led Luminous Flux</b>	110LM/W
<b>FPC Board</b>	10MM
<b>LED Quantity</b>	SMD2835 168P
<b>Product Luminous Flux (lm)</b>	1600lm±10%
<b>Led Brand</b>	EPISTAR
<b>CRI</b>	>80
<b>Beam Angle</b>	120 °
<b>SCDM</b>	<5 SDM
<b>Minimum cut length</b>	18MM
<b>Maximum connection length</b>	5M
<b>Warranty</b>	3 years
<b>Packaging Size(mm)</b>	385*350*210MM
<b>G.W(KGS)</b>	6.9KG/CTN

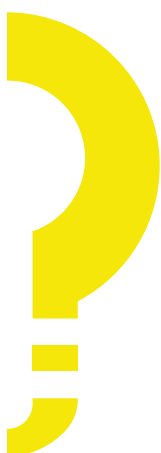



**PRODUCT SIZE**

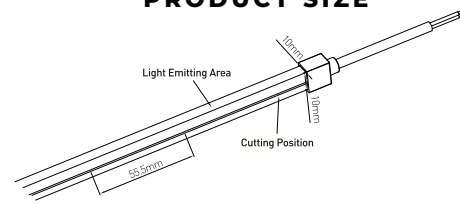

**AZ-IP65- 1010**

<b>Product</b>	AZ-IP65-1010
<b>IP Rating</b>	IP65/67
<b>ROHS Instruction</b>	Environmental protection
<b>Connection Type</b>	Simple type wire connection
<b>Color Temperature</b>	2200/3000k, multi color Temperature Optional
<b>Lifetime(h)</b>	30000H
<b>Input Power(W)</b>	9%W/M
<b>Input voltage</b>	24VDC
<b>Power Factor</b>	>0.9
<b>Storage Temperature</b>	-25°C~+55°C
<b>Working Temperature</b>	-25°C~+40°C
<b>Led Luminous Flux</b>	110LM/ W
<b>FPC Board</b>	8MM
<b>LED Quantity</b>	126 Pcs
<b>Product Luminous Flux (lm)</b>	750lm±10%/M
<b>Led Brand</b>	EPISTAR
<b>CRI</b>	>90
<b>Beam Angle</b>	120 °
<b>SCDM</b>	SDM 2835
<b>Minimum cut length</b>	50MM
<b>Maximum connection length</b>	5M
<b>Warranty</b>	3 years
<b>Packaging Size(mm)</b>	W10*H10 MM
<b>G.W(KGS)</b>	7.5KG/CTN

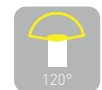

Beam Angle



Flame Resistant



UV Resistant



Solvents Resistant



IK08 Protection



PRODUCTS CATALOGUE | **LED STRIPS**

<b>Product</b>	Az-652420
<b>IP Rating</b>	IP65
<b>ROHS Instruction</b>	Environmental protection
<b>Connection Type</b>	Simple type wire connection
<b>Color Temperature</b>	3000/4000/6000K
<b>Lifetime(h)</b>	30000H
<b>Input Power(W)</b>	12±10%W/M
<b>Input voltage</b>	24VDC
<b>Power Factor</b>	>0.9
<b>Storage Temperature</b>	-30°C~+50°C
<b>Working Temperature</b>	-20°C~+40°C
<b>Led Luminous Flux</b>	110LM/W
<b>FPC Board</b>	10M M
<b>LED Quantity</b>	SMD2835 168P
<b>Product Luminous Flux (lm)</b>	1350lm±10%
<b>Led Brand</b>	EPISTAR
<b>CRI</b>	>80
<b>Beam Angle</b>	120 °
<b>SCDM</b>	<5 SDM
<b>Minimum cut length</b>	41.7MM
<b>Maximum connection length</b>	5M
<b>Warranty</b>	3 years
<b>Packaging Size(mm)</b>	520*430*270MM
<b>G.W(KGS)</b>	7.5KG/CTN

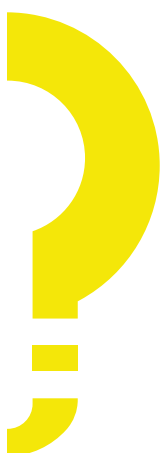



<b>Product</b>	AZ-38410
<b>IP Rating</b>	IP20
<b>Color Temperature</b>	3000K/4000K/6000K
<b>Power (W)</b>	10 W/ M
<b>Input Voltage</b>	24VDC
<b>Working Temperature</b>	-40°C~+50°C
<b>Led Luminous Flux</b>	100LM/W
<b>FPC Board</b>	8MM
<b>LED Quantity</b>	COB-384 PCS
<b>Product Luminous Flux (lm)</b>	1000lm±10%
<b>CRI</b>	>90
<b>Copper Thickness</b>	35UM+35UM
<b>Beam Angle</b>	180°
<b>Minimum cut length</b>	41.67MM
<b>Maximum connection length</b>	5M
<b>Warranty</b>	3 YEARS

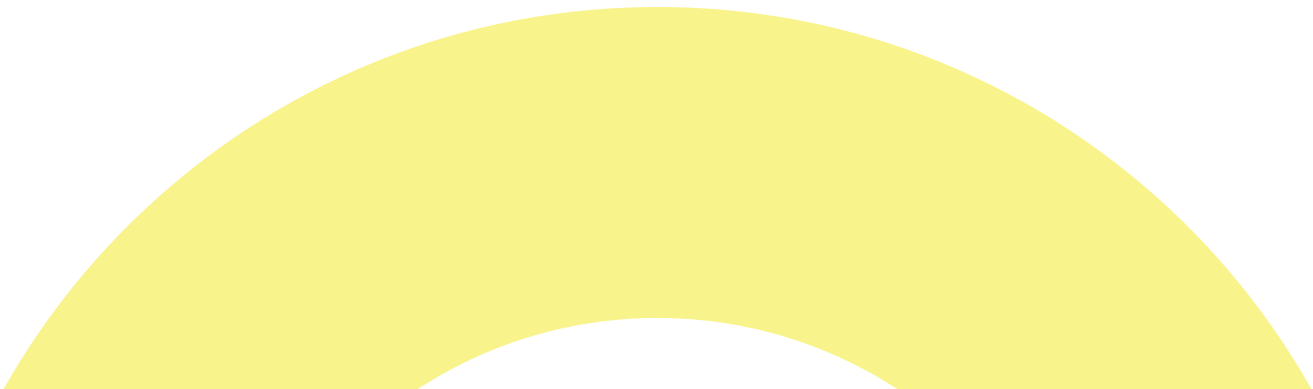

<b>Product</b>	Az-IP65-RGB-2415-65
<b>IP Rating</b>	IP65
<b>ROHS Instruction</b>	Environmental protection
<b>Connection Type</b>	Simple type wire connection
<b>Color Temperature</b>	RGB
<b>Lifetime(h)</b>	30000H
<b>Input Power(W)</b>	12±10%W/M
<b>Input voltage</b>	24VDC
<b>Power Factor</b>	>0.9
<b>Storage Temperature</b>	-30°C~+50°C
<b>Working Temperature</b>	-20°C~+40°C
<b>Led Luminous Flux</b>	22LM/W
<b>FPC Board</b>	10MM
<b>LED Quantity</b>	SMD3838-120 P
<b>Product Luminous Flux (lm)</b>	260lm±10 %
<b>Led Brand</b>	HSG
<b>Beam Angle</b>	120 °
<b>SCDM</b>	<5 SDM
<b>Minimum cut length</b>	50MM
<b>Maximum connection length</b>	5M
<b>Warranty</b>	3 years
<b>Packaging Size(mm)</b>	520*430*270MM
<b>G.W(KGS)</b>	21.2KG /CT N

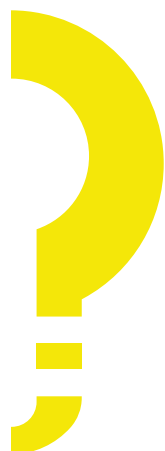

<b>Product</b>	Az-RGB-2415-20
<b>IP Rating</b>	IP20
<b>ROHS Instruction</b>	Environmental protection
<b>Connection Type</b>	Simple type wire connection
<b>Color Temperature</b>	RGB
<b>Lifetime(h)</b>	30000H
<b>Input Power(W)</b>	15±10%W/ M
<b>Input voltage</b>	24VDC
<b>Power Factor</b>	>0.9
<b>Storage Temperature</b>	-30°C~+50°C
<b>Working Temperature</b>	-20°C~+40°C
<b>Led Luminous Flux</b>	23LM/W
<b>FPC Board</b>	10MM
<b>LED Quantity</b>	SMD-3838-120P
<b>Product Luminous Flux (lm)</b>	350lm±10%
<b>Led Brand</b>	HSG
<b>Beam Angle</b>	120 °
<b>SCDM</b>	<5 SDM
<b>Minimum cut length</b>	50MM
<b>Maximum connection length</b>	5M
<b>Warranty</b>	3 years
<b>Packaging Size(mm)</b>	385*350*210MM
<b>G.W(KGS)</b>	6.8KG/CTN

**PRODUCT SIZE**

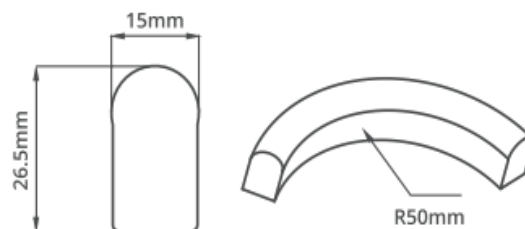

**AZ-2408-RGB U150**

<b>Model</b>		AZ-2408 U150
<b>Physical Specification</b>	IP grade	IP65 (Male and Female Connector)
	driver	Rectifier
	Manufacture process	SMT
	Connection	Male and Female Connector/Simple Connector
	Minimum cutting length	12" (1FT)
	Max. running length	20M/Roll(66FT)
	storage temperature	-30~50 °C
	operating temperature	-20~40 °C
	suitable environment humidity	0-90%
	Lifespan(h)	20000
<b>Electronic Specification</b>	output voltage	DC24V
	Power(W)	8W±10%
	Pressure testing rate	CLASS III
	insulation grade	CLASS III
	Control System	N/A
<b>Mechanical &amp; Physical Specification</b>	LED Source	SMD5050
	LED power	0.1W
	LED quantity	72led/Meters
	CCT	RGB
	luminous flux	/
	CRI (Ra)	/
	beam angle	120°
<b>Others</b>	Dimension	15mm*26.5mm
	installation	With Aluminum Profile
	material	Copper wire and PVC lamp body
	G.W.	10.2KG/CTN
	N.W.	10.9KG/CTN
	Unit product packing	Roller+Carton
	carton size (mm)	330*330*195MM
	max.package amount	10PCS

Note: 1.All parameters NOT specially mention are measured at 240VAC input and 25°C of ambient temperature.

# INSTALLATION

## 1 Molded connector

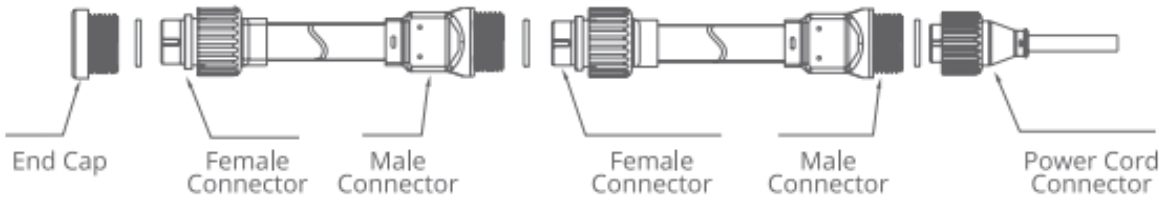

Length: 1.2m, 2x1.0mm<sup>2</sup> Rubber Wire in the Front with Male Connector



Male and Female Connector



5cm Aluminum profile with screw

## 2 Simple Assembled Connector



Length: 1.2m, 2x1.0mm<sup>2</sup> Rubber Wire in the Front with glue connector + End cap + Pin



Middle Connector + Pin



5cm Aluminum Profile with 2 screws

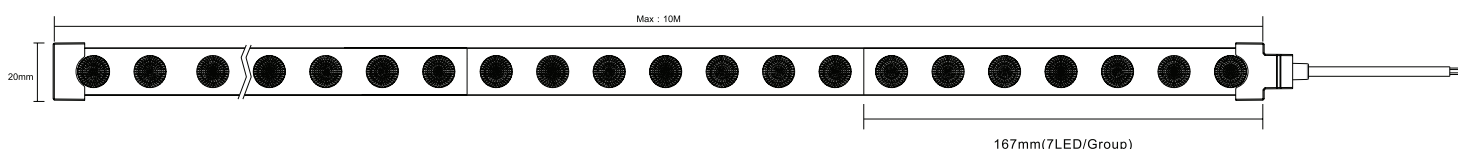

# FLEXIBLE LED WALL WASHER WITH OPTIC LENS

**AZ-IP65-6131**

		<b>94+</b> High CRI		<b>10M</b> roll	<b>24V</b> <b>DC</b>
--	--	------------------------	--	--------------------	-------------------------

**Notice:** Can be cutted by every 167mm, but we don't supply the fast connection, customers should do the soldering by themselves after cutting.

## PRODUCT FEATURES

- Multiple angles are available, different beam angles, for different environments, Optional angle: Single angle: 10°/30°/45°/60°/90°/110°
- Can replace the traditional LED strip to achieve the effect of wall-washing, can also be used as a cabinet lamp or household lighting.
- PC lens with Silicone encapsulation for durability, reliability, and ease of installation
- Run Length: 10m/Roll
- Mounting method: 3M glue tape or mounting clips or match with the aluminum profile



## PRODUCT PARAMETERS

Absolute Maximum Rating at TA=25°C

Parameter	Mark	Rated Value	Unit
<b>Forward Voltage DC</b>	VF	24VDC	V
<b>Forward Current</b>	IF	875	mA/M
<b>Power</b>	PD	<18	W/M
<b>CRI</b>	Ra	94+	/
<b>Luminous Flux</b>	Φ	3000K 1100LM	Lm(1M)
<b>PCB Width</b>	W	18	mm
<b>Completed Product Width</b>	W	20	mm
<b>Completed Product Thickness</b>	T	9	mm
<b>Min. Element Size</b>	L	167	mm
<b>Min. Buckling Radius</b>	R	≥150	mm
<b>IP Grade</b>	IP	IP67 PU +PC Lens (silicone encapsulation)	/
<b>LED Color Temperature</b>	CCT	1800K-6500K	K
<b>Beaming Angle</b>	2θ1/2	Single angle 30°	deg

## MOUNTING ACCESSORIES WITH LED TAPE LIGHT



Mounting bracket

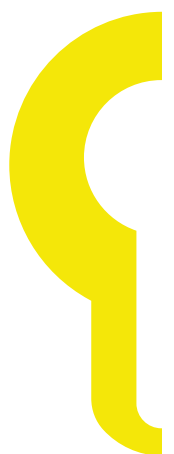

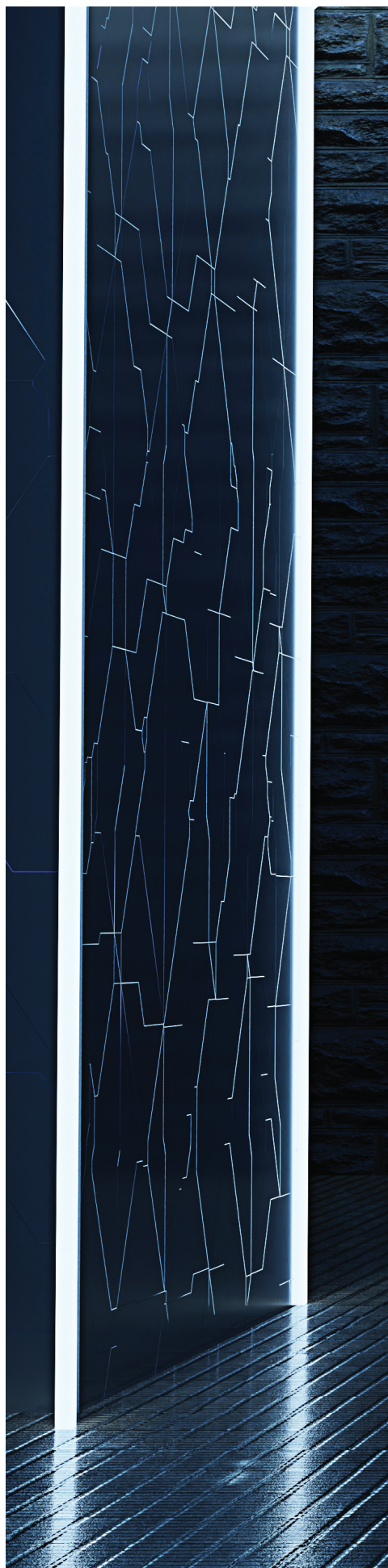

**AZ839**  
 SIZE: 10X13MM  
 COVER: MILKY WHITE

**AZ121**  
 SIZE: 16X16MM  
 COVER: MILKY WHITE

**AZ102**  
 SIZE: 24.5X6.85MM  
 COVER: MILKY WHITE

**AZ103**  
 SIZE: 17.6X6.85MM  
 COVER: MILKY WHITE

**AZ883**  
 SIZE: 18X4.80MM  
 COVER: MILKY WHITE

**AZ-R35**  
 SIZE: 50X35MM  
 COVER: MILKY WHITE

**AZ-887**  
 SIZE: 30X20MM  
 COVER: MILKY WHITE

**AZ-M150**  
 SIZE: 150X35MM  
 COVER: MILKY WHITE

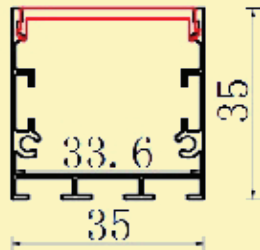

**AZ-M35**  
SIZE: 35X35MM  
COVER: MILKY WHITE

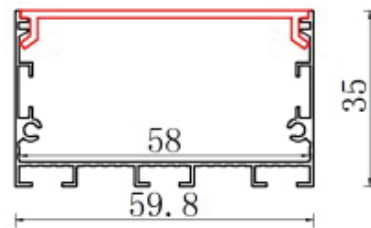

**AZ-M60**  
SIZE: 60X35MM  
COVER: MILKY WHITE

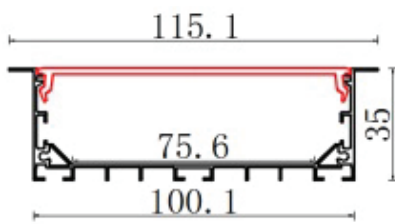

**AZ-R100**  
SIZE: 115X35MM  
COVER: MILKY WHITE

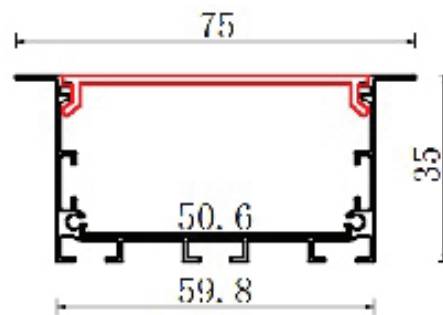

**AZ-R60**  
SIZE: 75X35MM  
COVER: MILKY WHITE

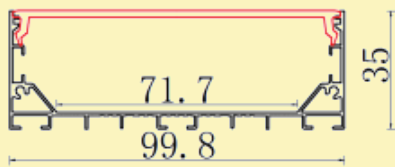

**AZ-M100**  
SIZE: 100X35MM  
COVER: MILKY WHITE

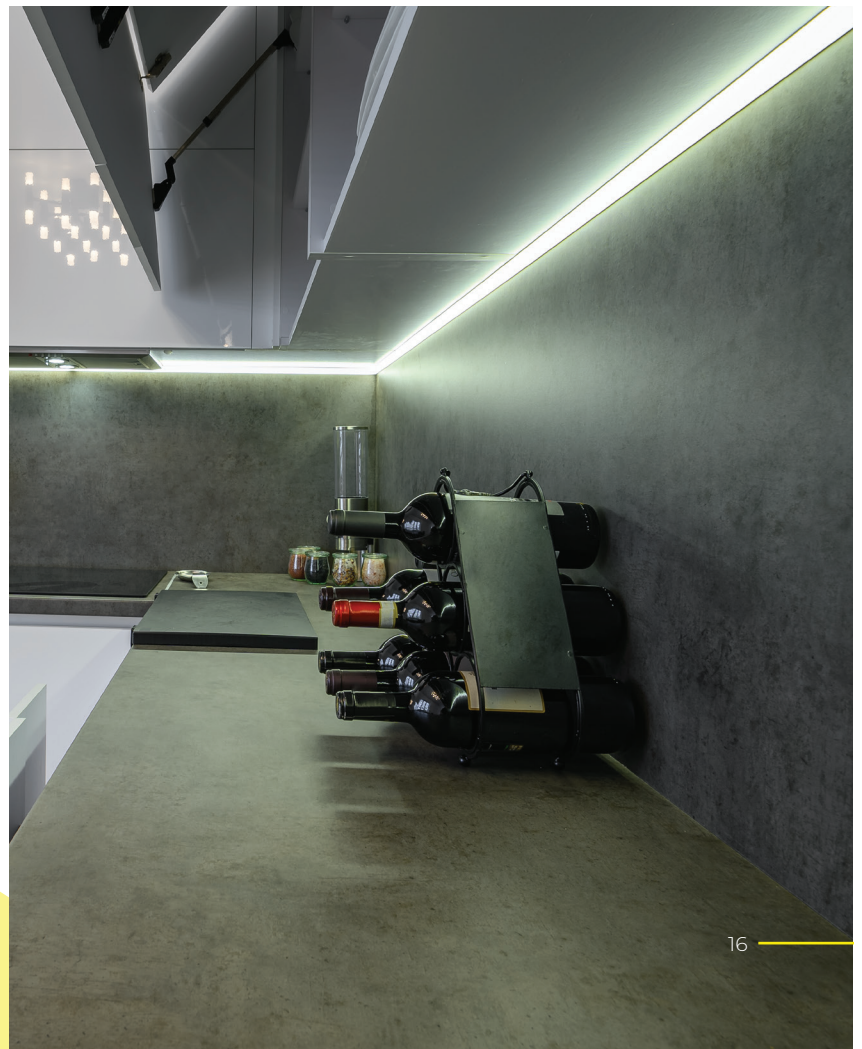

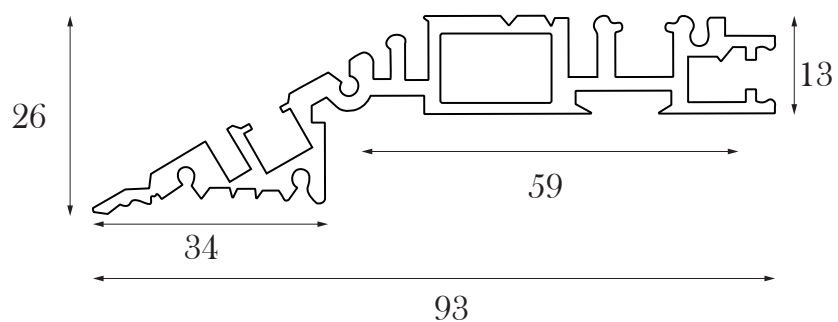

**0 EDGE PROFILE**  
SIZE: 75X35MM  
COVER: MILKY WHITE

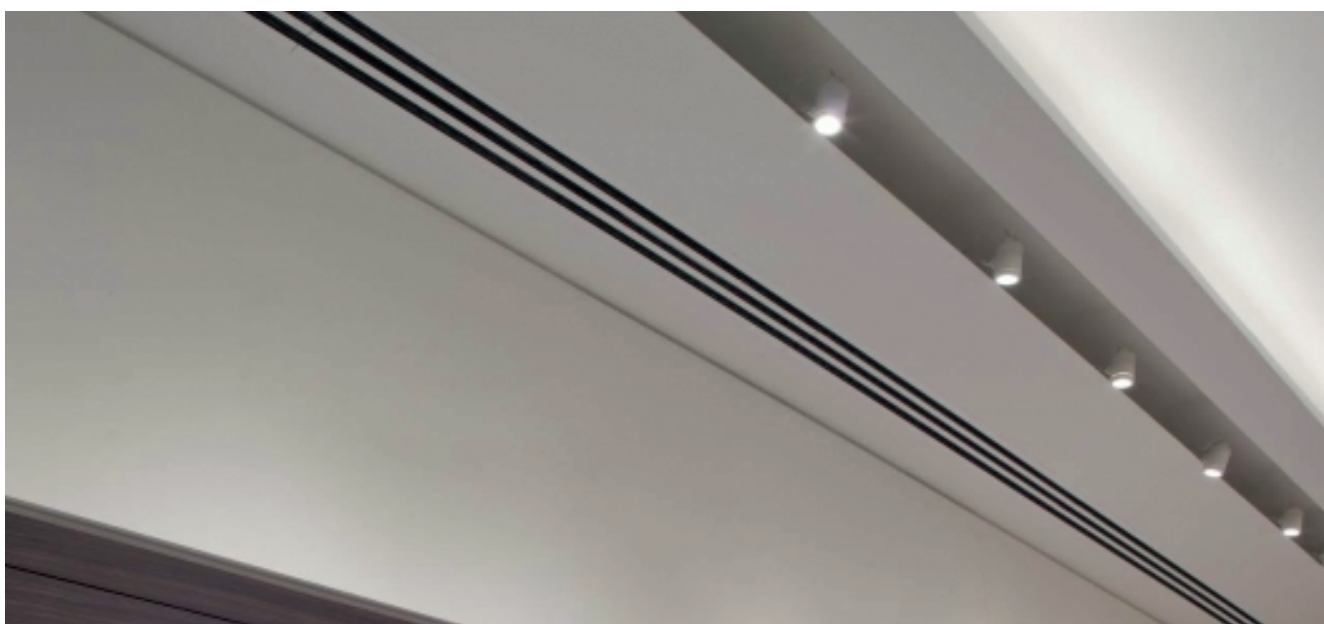

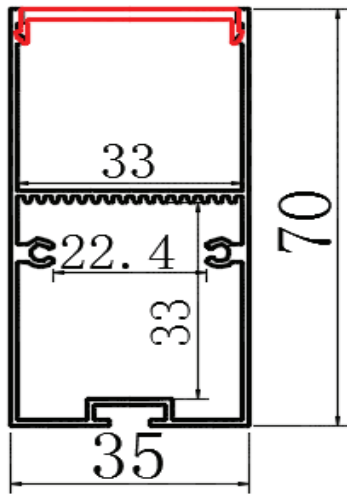

**AZ-D35**  
SIZE: 35X70MM  
COVER: MILKY WHITE

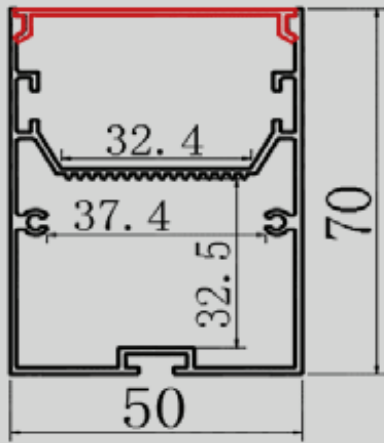

**AZ-D50**  
SIZE: 50X70MM  
COVER: MILKY WHITE

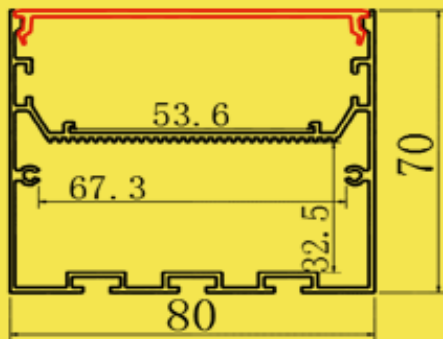

**AZ-D80**  
SIZE: 80X70MM  
COVER: MILKY WHITE

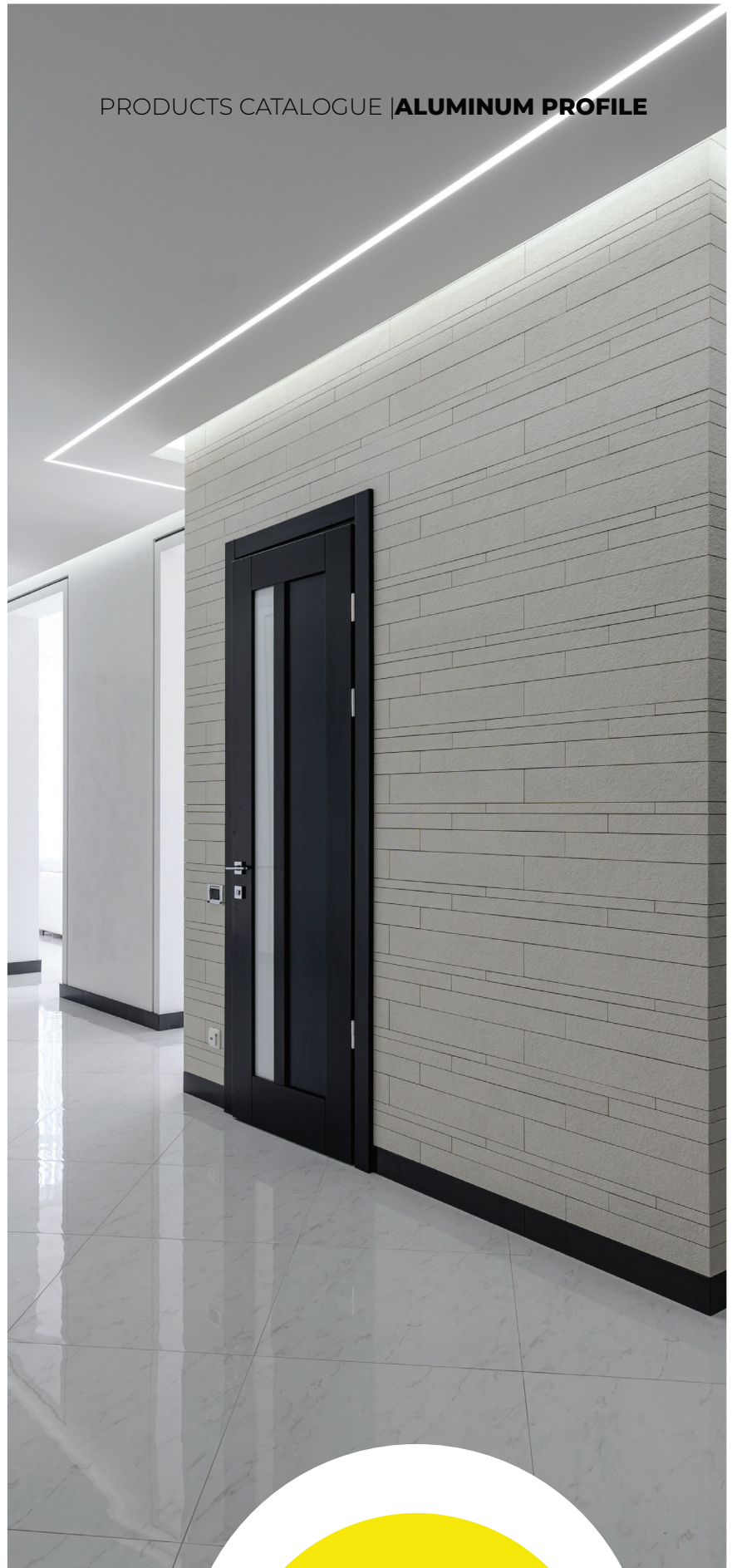

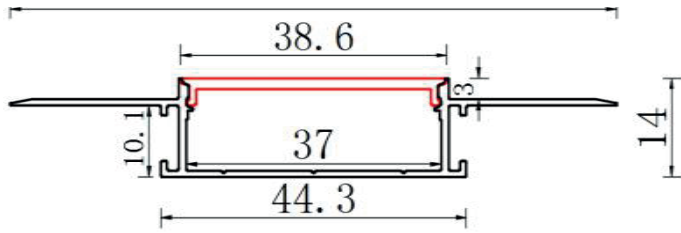

**AZ-840**  
SIZE: 88X14MM  
COVER: MILKY WHITE

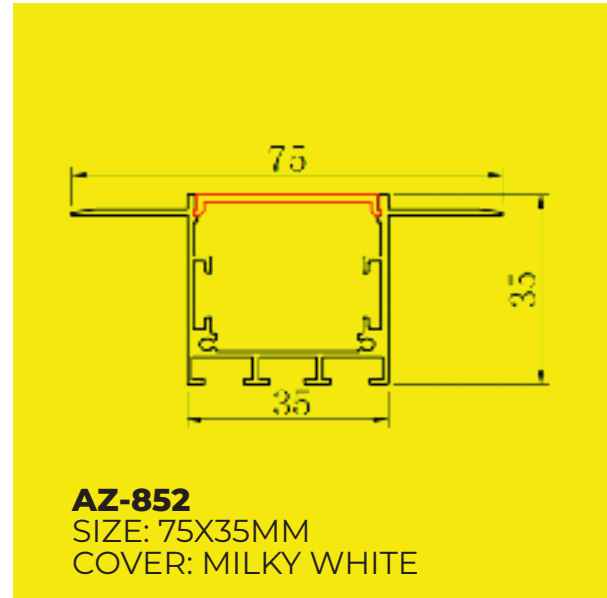

**AZ-852**  
SIZE: 75X35MM  
COVER: MILKY WHITE

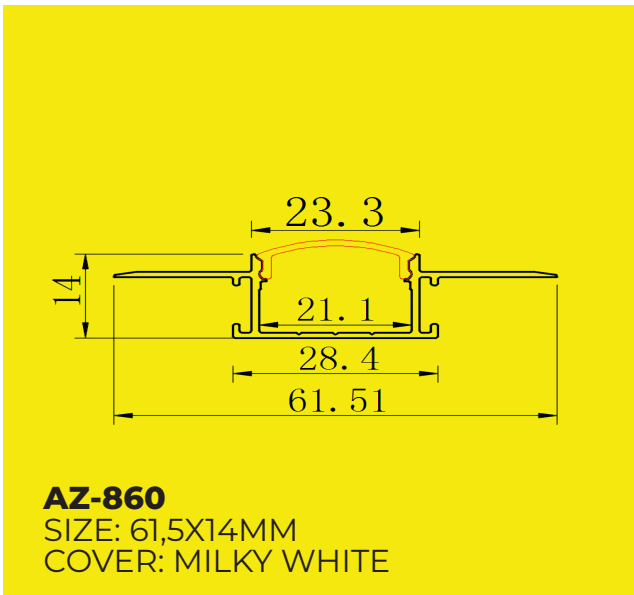

**AZ-860**  
SIZE: 61,5X14MM  
COVER: MILKY WHITE

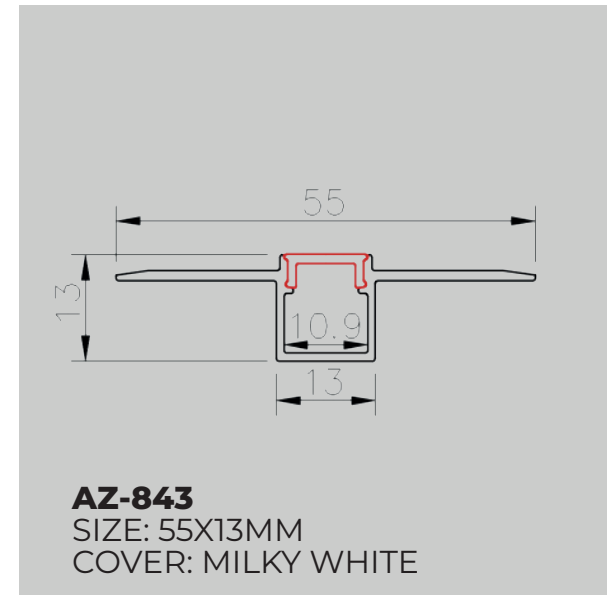

**AZ-843**  
SIZE: 55X13MM  
COVER: MILKY WHITE





**AZ-589**  
HAND RAIL  
BLACK PROFILE

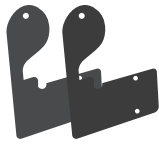

Endcap

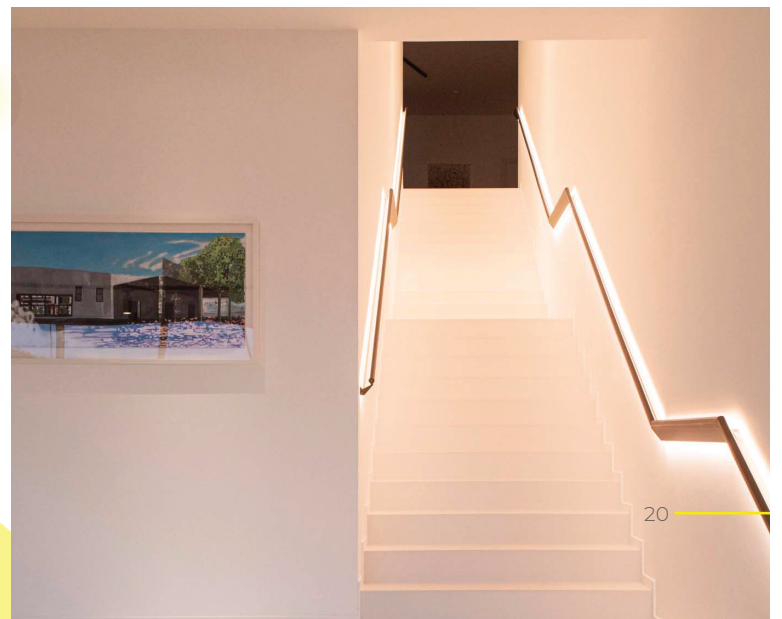
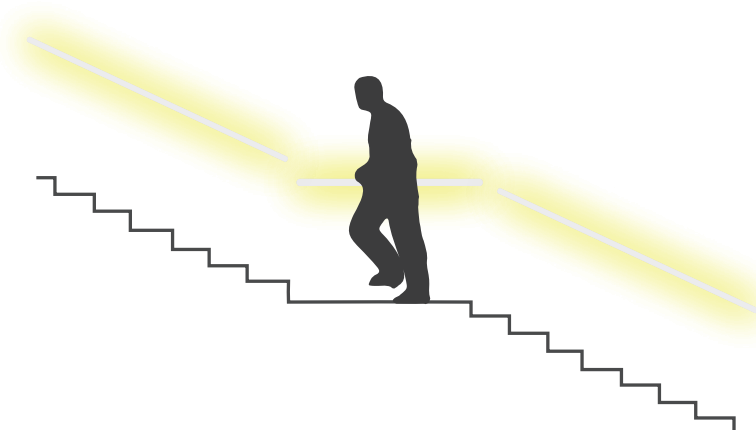
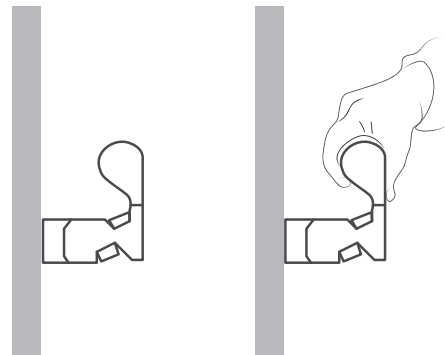

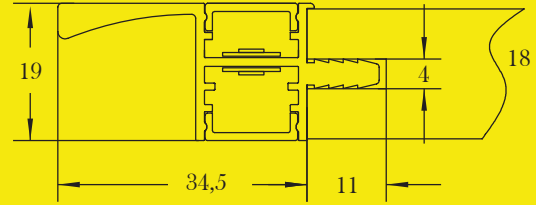

**AZ-777**  
SIZE: 44.5X19MM  
COVER: MILKY WHITE





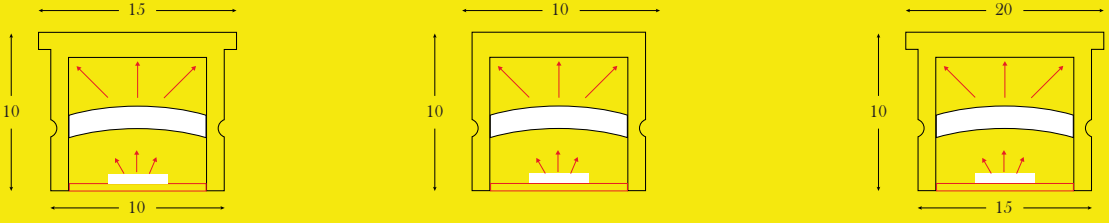

Technical diagrams showing the cross-sections of three aluminum profiles. Each diagram includes dimensions: height (10mm) and width (15mm, 10mm, and 20mm respectively). Red arrows indicate light distribution from the internal reflector.

**AZ-1010**  
SIZE:  
10X15MM

**AZ-1010M**  
SIZE:  
10X15MM

**AZ-1510**  
SIZE:  
10X20MM

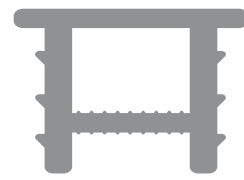

Technical diagrams showing the cross-sections of two aluminum profiles. Dimensions include height (10mm and 17mm) and width (15mm and 25mm). Red arrows indicate light distribution.

**AZ-1510M**  
SIZE:  
10X15MM

**AZ-2517M**  
SIZE:  
17X25MM

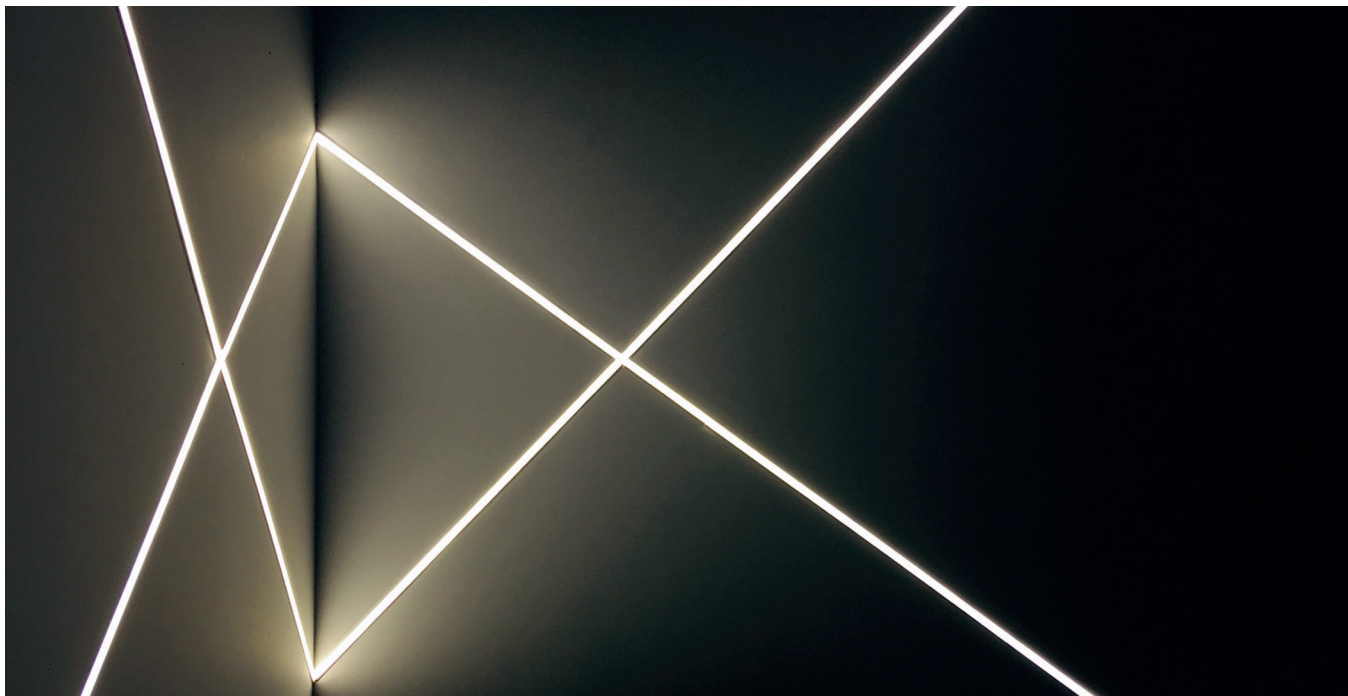







**KEYLIGHT**  
**SPAIN**  
LIGHTING PRODUCTS

**KEYLIGHT BY LUCREATIVE**

TEL: +34 677 65 56 22

EMAIL: [INFO@KEYLIGHTSPAIN.EU](mailto:INFO@KEYLIGHTSPAIN.EU)